DEWALT®

XR LI-ION

www.DEWALT.com

DCT414-XE

Fig. A

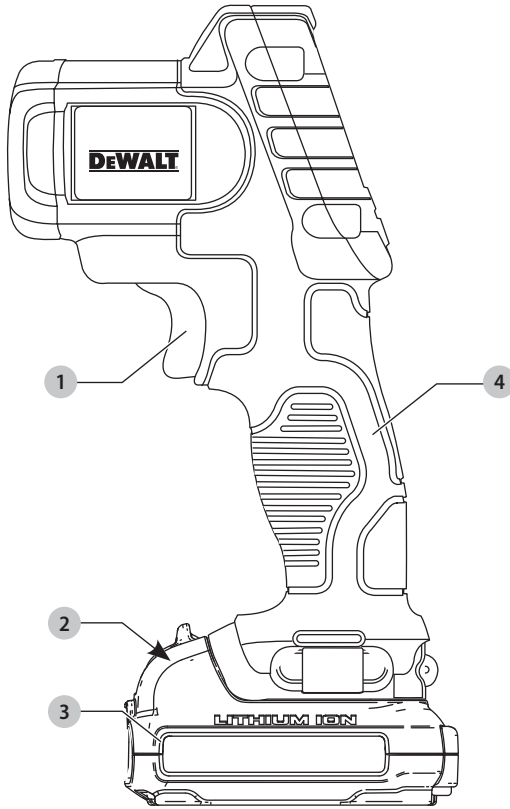

Fig. B

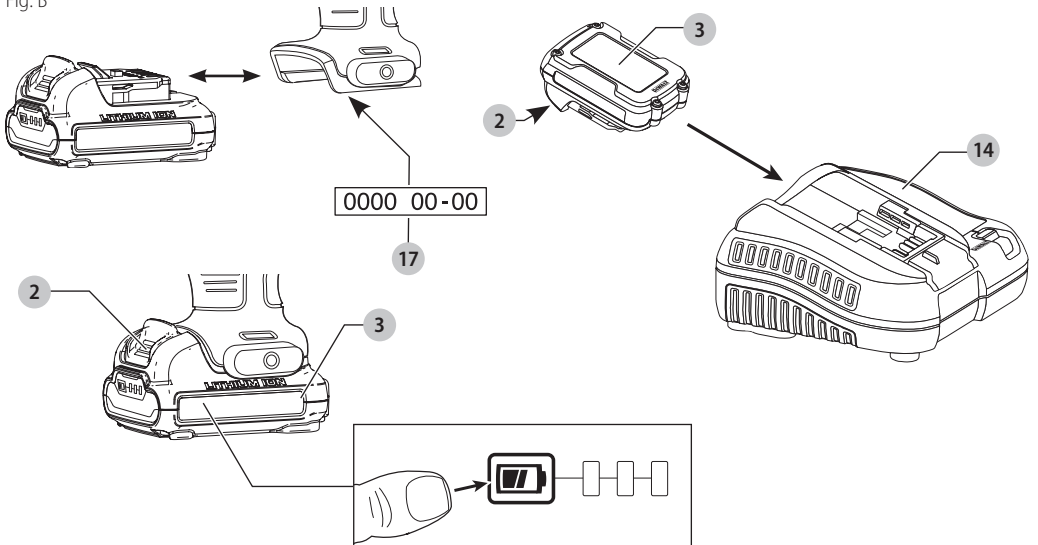

Fig. C

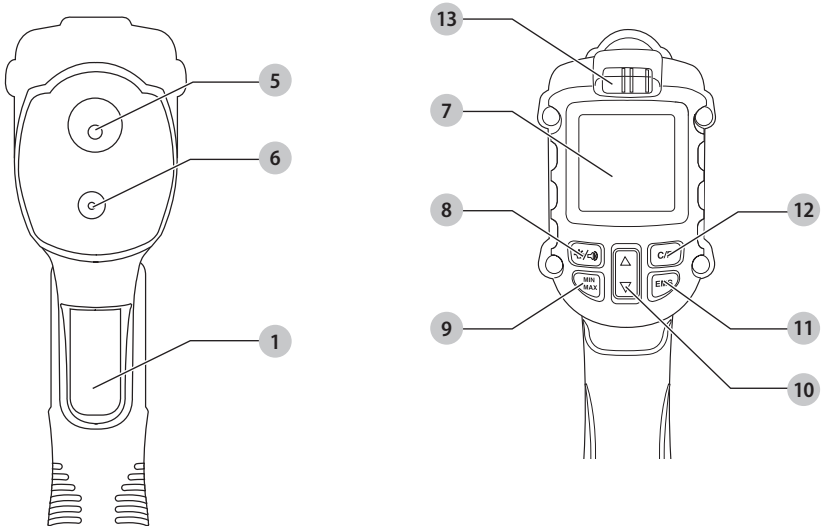

Fig. D

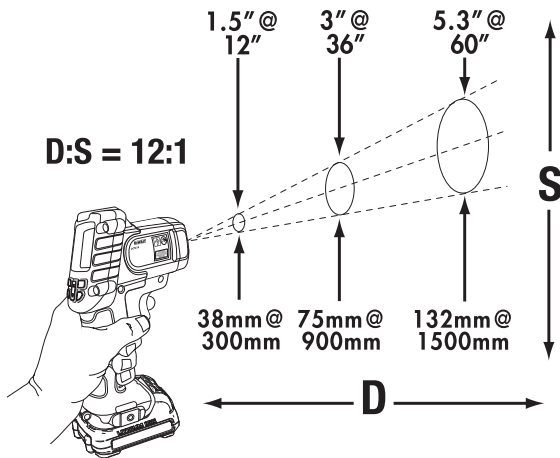
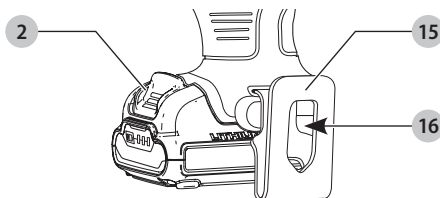

Fig. E



12V CORDLESS IR THERMOMETER

DCT414-XE

Congratulations!

You have chosen a DEWALT tool. Years of experience, thorough product development and innovation make DEWALT one of the most reliable partners for professional power tool users.

Technical Data

		DCT414-XE
Voltage		
Peak	V_{DC}	12
Rated	V_{DC}	10.8
Type		1
Battery type		Li-Ion
Power output	W	0.5
Distance to spot	D:S	Approximately 12:1
Temperature range		-30 °C – 550 °C (-22 °F – 1022 °F)
Emissivity		0.1 to 1
Emissivity adjustability		in 0.01 increments
Accuracy		+/-1.5% or +/-1.5 °C (+/-1.5% or +/- 35 °F), whichever is greater on a black body source (EMS 0.95)
Laser power	mW	< 1, CLASS 2 LASER PRODUCT
Laser wavelength	nm	620–690
Weight (without battery pack)	kg	0.3

Laser Information

The Infrared Thermometer (IR thermometer) is a Class 2 laser product and complies with 21 CFR 1040.10 and 1040.11 except for deviations pursuant to laser notice No. 50, dated June 24, 2007.

EC-Declaration of Conformity



DEWALT hereby declares that this DEWALT Bluetooth® product is in compliance with the Directive 2014/53/EU and to all applicable EU directive requirements.

The full text of the EU declaration of conformity can be requested at DEWALT, Richard-Klinger-Straße 11, D-65510, Idstein, Germany or is available at the following internet address: www.2helpu.com

Search by the Product and Type Number indicated on the nameplate.

For more information, please contact DEWALT at the address in the back of the manual.



WARNING: To reduce the risk of injury, read the instruction manual.

Definitions: Safety Guidelines

The definitions below describe the level of severity for each signal word. Please read the manual and pay attention to these symbols.



DANGER: Indicates an imminently hazardous situation which, if not avoided, **will** result in **death or serious injury**.



WARNING: Indicates a potentially hazardous situation which, if not avoided, **could** result in **death or serious injury**.



CAUTION: Indicates a potentially hazardous situation which, if not avoided, **may** result in **minor or moderate injury**.

NOTICE: Indicates a practice **not related to personal injury** which, if not avoided, **may** result in **property damage**.



Denotes risk of electric shock.



Denotes risk of fire.

General Tool Safety Warnings



WARNING: Read all safety warnings and all instructions. Failure to follow the warnings and instructions may result in electric shock, fire and/or serious injury.

SAVE ALL WARNINGS AND INSTRUCTIONS FOR FUTURE REFERENCE

The term "power tool" in the warnings refers to your mains-operated (corded) power tool or battery-operated (cordless) power tool.

1) Work area safety

- Keep work area clean and well lit.** Cluttered or dark areas invite accidents.
- Do not operate tools in explosive atmospheres, such as in the presence of flammable liquids, gases or dust.**
- Keep children and bystanders away while operating a tool.**

2) Personal safety

- Stay alert, watch what you are doing and use common sense when operating a tool. Do not use a tool while you are tired or under the influence of drugs, alcohol or medication.** A moment of inattention while operating tools may result in serious personal injury.
- Do not overreach. Keep proper footing and balance at all times.** This enables better control of the tool in unexpected situations.

Batteries				Chargers/Charge Times (Minutes)								
Cat #	V _{DC}	Ah	Weight kg	DCB104	DCB107	DCB110	DCB112	DCB113	DCB115	DCB116	DCB132	DCB119
DCB122	12	2.0	0.22	30	90	90	60	50	30	30	30	60
DCB124/G	12	3.0	0.25	45	140	140	90	70	45	45	45	90
DCB125	12	1.3	0.20	22	60	60	40	30	22	22	22	40
DCB126/G	12	5.0	0.46	75	240	240	150	120	75	75	75	150
DCB127	12	2.0	0.22	30	90	90	60	50	30	30	30	60

- c) **Do not allow persons unfamiliar with the tool or these instructions to operate the tool.** Tools are dangerous in the hands of untrained users.
- d) **Maintain tools. Check for misalignment or binding of moving parts, breakage of parts and any other condition that may affect the tool's operation. If damaged, have the tool repaired before use.** Many accidents are caused by poorly maintained tools.

3) Battery tool use and care

- a) **Recharge only with the charger specified by the manufacturer.** A charger that is suitable for one type of battery pack may create a risk of fire when used with another battery pack.
- b) **Use tools only with specifically designated battery packs.** Use of any other battery packs may create a risk of injury and fire.
- c) **When battery pack is not in use, keep it away from other metal objects like paper clips, coins, keys, nails, screws or other small metal objects that can make a connection from one terminal to another.** Shorting the battery terminals together may cause burns or a fire.
- d) **Under abusive conditions, liquid may be ejected from the battery, avoid contact. If contact accidentally occurs, flush with water. If liquid contacts eyes, additionally seek medical help.** Liquid ejected from the battery may cause irritation or burns.

4) Service

- a) **Have your tool serviced by a qualified repair person using only identical replacement parts.** This will ensure that the safety of the tool is maintained.

Additional Specific Safety Rules for IR Thermometers

 **WARNING: Laser Radiation Exposure.** Do not disassemble or modify the IR thermometers. There are no user serviceable parts inside. Serious eye injury could result.

 **WARNING: Hazardous Radiation.** Use of controls or adjustments or performance of procedures other than those specified herein may result in hazardous radiation exposure.

- **Do not operate the IR thermometers in explosive atmospheres, such as in the presence of flammable**

liquids, gases, or dust. Tools create sparks which may ignite the dust or fumes.

- **Use the IR thermometer only with the specifically designated DEWALT batteries.** Use of any other batteries may create a risk of fire.
- **Store the IR thermometer out of reach of children and other untrained persons.** Lasers are dangerous in the hands of untrained users.
- **Tool service must be performed only by qualified repair personnel. Service or maintenance performed by unqualified personnel may result in injury.** Refer to the back cover for local service centres.
- **Do not use optical tools such as a telescope or transit to view the laser beam.** Serious eye injury could result.
- **Do not place the IR thermometer in a position which may cause anyone to intentionally or unintentionally stare into the laser beam.** Serious eye injury could result.
- **Do not disassemble the IR thermometer.** There are no user serviceable parts inside.
- **Do not modify the IR thermometer in any way.** Modifying the tool may result in hazardous laser radiation exposure.
- **Do not operate the IR thermometer around children or allow children to operate the laser.** Serious eye injury may result.
- **Do not remove or deface warning labels.** Removing labels increases the risk of exposure to radiation.
- **Do not use IR thermometer for testing temperatures of cooked or uncooked food.**
- **Do not use for taking human body temperature.**



CAUTION: Use of controls or adjustments or performance of procedures other than those specified herein may result in hazardous radiation exposure.

- To avoid damaging the IR Thermometer or the equipment under test, protect them from the following:
 - EMF (electromagnetic fields) like from arc welders, induction heaters, etc.



WARNING: This device contains sensitive circuitry that may be affected by radio frequency electromagnetic fields. Such influence may be present when the measured values are not stable, displayed values are varying greatly and it is impossible to carry out a measurement. Try to avoid the operation in the vicinity of radio transmitters.

reassembly may result in a risk of electric shock, electrocution or fire.

- In case of damaged power supply cord the supply cord must be replaced immediately by the manufacturer, its service agent or similar qualified person to prevent any hazard.
- **Disconnect the charger from the outlet before attempting any cleaning. This will reduce the risk of electric shock.** Removing the battery pack will not reduce this risk.
- **NEVER** attempt to connect two chargers together.
- **The charger is designed to operate on standard 230V household electrical power. Do not attempt to use it on any other voltage.** This does not apply to the vehicular charger.









Charging a Battery (Fig. B)

1. Plug the charger into an appropriate outlet before inserting battery pack.
2. Insert the battery pack **3** into the charger, making sure the battery pack is fully seated in the charger. The red (charging) light will blink repeatedly indicating that the charging process has started.
3. The completion of charge will be indicated by the red light remaining ON continuously. The battery pack is fully charged and may be used at this time or left in the charger. To remove the battery pack from the charger, push the battery release button **2** on the battery pack.

NOTE: To ensure maximum performance and life of lithium-ion battery packs, charge the battery pack fully before first use.

Charger Operation

Refer to the indicators below for the charge status of the battery pack.

Charge Indicators	
	Charging  
	Fully Charged  
	Hot/Cold Pack Delay*  

*The red light will continue to blink, but a yellow indicator light will be illuminated during this operation. Once the battery pack has reached an appropriate temperature, the yellow light will turn off and the charger will resume the charging procedure. The compatible charger(s) will not charge a faulty battery pack. The charger will indicate faulty battery by refusing to light.

NOTE: This could also mean a problem with a charger.

If the charger indicates a problem, take the charger and battery pack to be tested at an authorised service centre.

Hot/Cold Pack Delay

When the charger detects a battery pack that is too hot or too cold, it automatically starts a Hot/Cold Pack Delay, suspending charging until the battery pack has reached an appropriate temperature. The charger then automatically switches to the pack charging mode. This feature ensures maximum battery pack life.

A cold battery pack will charge at a slower rate than a warm battery pack. The battery pack will charge at that slower rate throughout the entire charging cycle and will not return to maximum charge rate even if the battery pack warms.

Electronic Protection System

XR Li-Ion tools are designed with an Electronic Protection System that will protect the battery pack against overloading, overheating or deep discharge.

The tool will automatically turn off if the Electronic Protection System engages. If this occurs, place the lithium-ion battery pack on the charger until it is fully charged.

Wall Mounting

These chargers are designed to be wall mountable or to sit upright on a table or work surface. If wall mounting, locate the charger within reach of an electrical outlet, and away from a corner or other obstructions which may impede air flow. Use the back of the charger as a template for the location of the mounting screws on the wall. Mount the charger securely using drywall screws (purchased separately) at least 25.4 mm long with a screw head diameter of 7–9 mm, screwed into wood to an optimal depth leaving approximately 5.5 mm of the screw exposed. Align the slots on the back of the charger with the exposed screws and fully engage them in the slots.

Charger Cleaning Instructions



WARNING: Shock hazard. Disconnect the charger from the AC outlet before cleaning. Dirt and grease may be removed from the exterior of the charger using a cloth or soft non-metallic brush. Do not use water or any cleaning solutions. Never let any liquid get inside the tool; never immerse any part of the tool into a liquid.

Battery Packs

Important Safety Instructions for All Battery Packs

When ordering replacement battery packs, be sure to include catalogue number and voltage.

The battery pack is not fully charged out of the carton. Before using the battery pack and charger, read the safety instructions below. Then follow charging procedures outlined.

READ ALL INSTRUCTIONS

- **Do not charge or use battery in explosive atmospheres, such as in the presence of flammable liquids, gases or dust.** Inserting or removing the battery from the charger may ignite the dust or fumes.
- **Never force battery pack into charger. Do not modify battery pack in any way to fit into a non-compatible charger as battery pack may rupture causing serious personal injury.**
- Charge the battery packs only in DEWALT chargers.
- **DO NOT splash or immerse in water or other liquids.**
- **Do not store or use the tool and battery pack in locations where the temperature may fall below 4 °C (34 °F) (such as outside sheds or metal buildings in winter), or reach**

or exceed 40 °C (104 °F) (such as outside sheds or metal buildings in summer).

- **Do not incinerate the battery pack even if it is severely damaged or is completely worn out.** The battery pack can explode in a fire. Toxic fumes and materials are created when lithium-ion battery packs are burned.
- **If battery contents come into contact with the skin, immediately wash area with mild soap and water.** If battery liquid gets into the eye, rinse water over the open eye for 15 minutes or until irritation ceases. If medical attention is needed, the battery electrolyte is composed of a mixture of liquid organic carbonates and lithium salts.
- **Contents of opened battery cells may cause respiratory irritation.** Provide fresh air. If symptoms persists, seek medical attention.



WARNING: Burn hazard. Battery liquid may be flammable if exposed to spark or flame.



WARNING: Never attempt to open the battery pack for any reason. If battery pack case is cracked or damaged, do not insert into charger. Do not crush, drop or damage battery pack. Do not use a battery pack or charger that has received a sharp blow, been dropped, run over or damaged in any way (i.e., pierced with a nail, hit with a hammer, stepped on). Electric shock or electrocution may result. Damaged battery packs should be returned to service centre for recycling.



WARNING: Fire hazard. Do not store or carry the battery pack so that metal objects can contact exposed battery terminals. For example, do not place the battery pack in aprons, pockets, tool boxes, product kit boxes, drawers, etc., with loose nails, screws, keys, etc.



CAUTION: When not in use, place tool on its side on a stable surface where it will not cause a tripping or falling hazard. Some tools with large battery packs will stand upright on the battery pack but may be easily knocked over.

Transportation



WARNING: Fire hazard. Transporting batteries can possibly cause fire if the battery terminals inadvertently come in contact with conductive materials. When transporting batteries, make sure that the battery terminals are protected and well insulated from materials that could contact them and cause a short circuit.

NOTE: Lithium-ion batteries should not be put in checked baggage.

DEWALT batteries comply with all applicable shipping regulations as prescribed by industry and legal standards which include UN Recommendations on the Transport of Dangerous Goods; International Air Transport Association (IATA) Dangerous Goods Regulations, International Maritime Dangerous Goods (IMDG) Regulations, and the European Agreement Concerning The International Carriage of Dangerous Goods by Road (ADR). Lithium-ion cells and batteries have been tested to section 38.3 of the UN Recommendations on the Transport of Dangerous Goods Manual of Tests and Criteria.

In most instances, shipping a DEWALT battery pack will be excepted from being classified as a fully regulated Class 9 Hazardous Material. In general, only shipments containing a lithium-ion battery with an energy rating greater than 100 Watt Hours (Wh) will require being shipped as fully regulated Class 9. All lithium-ion batteries have the Watt Hour rating marked on the pack. Furthermore, due to regulation complexities, DEWALT does not recommend air shipping lithium-ion battery packs alone regardless of Watt Hour rating. Shipments of tools with batteries (combo kits) can be air shipped as excepted if the Watt Hour rating of the battery pack is no greater than 100 Whr. Regardless of whether a shipment is considered excepted or fully regulated, it is the shipper's responsibility to consult the latest regulations for packaging, labeling/marketing and documentation requirements.

The information provided in this section of the manual is provided in good faith and believed to be accurate at the time the document was created. However, no warranty, expressed or implied, is given. It is the buyer's responsibility to ensure that its activities comply with the applicable regulations.

Storage Recommendations

1. The best storage place is one that is cool and dry away from direct sunlight and excess heat or cold. For optimum battery performance and life, store battery packs at room temperature when not in use.
2. For long storage, it is recommended to store a fully charged battery pack in a cool, dry place out of the charger for optimal results.

NOTE: Battery packs should not be stored completely depleted of charge. The battery pack will need to be recharged before use.

Labels on Charger and Battery Pack

In addition to the pictographs used in this manual, the labels on the charger and the battery pack may show the following pictographs:



Read instruction manual before use.



See **Technical Data** for charging time.



Do not probe with conductive objects.



Do not charge damaged battery packs.



Do not expose to water.



Have defective cords replaced immediately.



Charge only between 4 °C and 40 °C.



Only for indoor use.



Discard the battery pack with due care for the environment.



Charge DeWALT battery packs only with designated DeWALT chargers. Charging battery packs other than the designated DeWALT batteries with a DeWALT charger may make them burst or lead to other dangerous situations.



Do not incinerate the battery pack.

Battery Type

The DCT414-XE operates on a 12 volt battery pack.

These battery packs may be used: DCB122, DCB124, DCB125, DCB127. Refer to **Technical Data** for more information.

Package Contents

The package contains:

- 1 IR Thermometer
- 1 Charger
- 1 Battery
- 1 Instruction manual

NOTE: Battery packs, chargers and kitboxes are not included with N models. Battery packs and chargers are not included with NT models. B models include Bluetooth® battery packs.

- Check for damage to the tool, parts or accessories which may have occurred during transport.
- Take the time to thoroughly read and understand this manual prior to operation.

Emissivity

Emissivity describes the energy-emitting characteristics of materials. Most organic materials and painted or oxidized surfaces have an emissivity of about 0.95, which is the default setting. It is recommended to compensate for inaccurate readings that may result from measuring materials with low emissivity values such as shiny metal surfaces. Cover these surfaces with masking tape or flat black paint (<148 °C/ 300 °F) and use the default (0.95) setting. Allow time for the tape or paint to reach the same temperature as the surface beneath it and then measure the temperature of the tape or painted surface.

If you cannot paint or use tape, then you can compensate your measurements with the emissivity selector. Even with the adjustable emissivity, it can be difficult to get a completely accurate infrared measurement of a target with a shiny or metallic surface. Experimentation may be required to benchmark temperatures, and experience will help you choose the best setting for specific measurements.

The thermometer has emissivity adjustable from 0.1 to 1.0 in increments of 0.01. Refer to the **Nominal Emissivity Table** in this manual. The reference to emissivity settings in the table are suggestions for typical situations and your particular situation may differ.

NOTE: Calibration of this product was performed at 0.95 emissivity.

Environmental Conditions

- This tool is intended for indoor use only.
- Use at an altitude of up to 2000 m.
- Use at a maximum relative humidity 80% for temperatures up to 31 °C (87 °F), decreasing linearly to 50% relative humidity at 40 °C (104 °F).
- Only applicable POLLUTION DEGREE of the intended environment: POLLUTION DEGREE 2.
- General working temperature should be from 5 °C (41 °F) to 40 °C (104 °F).

Markings on Tool

The following pictograms are shown on the tool:



Read instruction manual before use.



Alarm Mode Button: Used to select the type of alarm and to set the high (HAL) and low (LAL) temperature limits for the alarm.



Min/Max/Avg Mode Button: Displays either the lowest, highest or average temperature.



Adjustment Button: Used with each mode button to set desired value.



EMS Mode Button: Set emissivity value.



C/F Mode Button: Used to set temperature units of measure (Celsius or Fahrenheit).



Visible radiation. Do not stare into light.

Date Code Position (Fig. B)

The date code **17**, which also includes the year of manufacture, is printed into the housing.

Example:

2022 XX XX
Year of Manufacture

Description (Fig. A–C, E)



WARNING: Never modify the power tool or any part of it. Damage or personal injury could result.

- | | |
|-----------------------------------|---------------------------|
| 1 Measurement trigger | 7 LCD screen |
| 2 Battery release button | 8 Alarm mode button |
| 3 DeWALT 12 V lithium-ion battery | 9 Min/Max/Avg mode button |
| 4 Main handle | 10 Adjustment button |
| 5 IR sensor | 11 EMS mode button |
| 6 Laser/pointer beam | 12 C/F mode button |

13 LED indicator

15 Belt hook

14 Battery charger

16 Screw

Alarm Mode Button

The alarm is used to select the type of alarm and to set the high (HAL) and low (LAL) temperature limits for the alarm.

Alarm 1 temperature has reached the set limit, indicated by the red/blue LED **13**

Alarm 2 temperature has reached the set limit, indicated by a beeper sound

Alarm 3 temperature has reached the set limit, indicated by both the LED and the beeper

Min/Max/Avg Mode Button

The Min/Max/Avg mode button displays either the lowest, highest or average temperature.

Adjustment Button

Used with each mode button to set desired value.

EMS Mode Button

The EMS mode button sets emissivity value.

C/F Mode Button

Used to set temperature units of measure (Celsius or Fahrenheit).

LED Indicator

LED indicator is active in Alarm 1 and Alarm 3 modes.

Blue: serves as an alarm to show that temperature has reached the set **minimum**.

Red: serves as an alarm to show that temperature has reached the set **maximum**.

Screen icons

Hold – will display when you have released the trigger, to let you know that was the last temperature read.

Scan – will display when you hold the trigger down looking for differing temperatures.

Alarm setting – this icon will let you know what alarm you have chosen to display: color indicator, beep or both.

F or C – indicates units of measure for temperature.

Battery – will indicate how much charge is remaining on the battery.

NOTE: The low battery indicator is located directly above the temperature reading on the screen. The bars on the low battery indicator will indicate the strength of the battery. The IR Thermometer may continue to operate for a short time while the batteries continue to drain, but the beams will quickly dim. After fresh batteries are installed, and the IR Thermometer is turned on again, the IR Thermometer will return to its full brightness.

Intended Use

The IR Thermometer measures surface temperatures by measuring the amount of infrared emitted off the object. This type of measurement is a non-contact measurement of the surface's temperature. This tool comes fully assembled. This

tool has been designed with features that allow for quick and easy set-up.

DO NOT use under wet conditions or in the presence of flammable liquids or gases.

This IR Thermometer is a professional tool.

DO NOT let children come into contact with the tool.

Supervision is required when inexperienced operators use this tool.

- **Young children and the infirm.** This appliance is not intended for use by young children or infirm persons without supervision.
- This product is not intended for use by persons (including children) suffering from diminished physical, sensory or mental abilities; lack of experience, knowledge or skills unless they are supervised by a person responsible for their safety. Children should never be left alone with this product.

ASSEMBLY AND ADJUSTMENTS



WARNING: To reduce the risk of serious personal injury, turn tool off and disconnect battery pack before making any adjustments or removing/installing attachments or accessories. An accidental start-up can cause injury.



WARNING: Use only DEWALT battery packs and chargers.

Inserting and Removing the Battery Pack from the Tool (Fig. B)

NOTE: Make sure your battery pack **3** is fully charged.

To Install the Battery Pack into the Tool Handle

1. Align the battery pack **3** with the rails inside the tool's handle (Fig. B).
2. Slide it into the handle until the battery pack is firmly seated in the tool and ensure that you hear the lock snap into place.

To Remove the Battery Pack from the Tool

1. Press the release button **2** and firmly pull the battery pack out of the tool handle.
2. Insert battery pack into the charger as described in the charger section of this manual.

Fuel Gauge Battery Packs (Fig. B)

Some DEWALT battery packs include a fuel gauge which consists of three green LED lights that indicate the level of charge remaining in the battery pack.

To actuate the fuel gauge, press and hold the fuel gauge button. A combination of the three green LED lights will illuminate designating the level of charge left. When the level of charge in the battery is below the usable limit, the fuel gauge will not illuminate and the battery will need to be recharged.

NOTE: The fuel gauge is only an indication of the charge left on the battery pack. It does not indicate tool functionality and is subject to variation based on product components, temperature and end-user application.

Belt Hook (Optional Accessory, Fig. E)

 **WARNING:** To reduce the risk of serious personal injury, DO NOT suspend tool overhead or suspend objects from the belt hook. ONLY hang tool's belt hook from a work belt.

 **WARNING:** To reduce the risk of serious personal injury, ensure the screw holding the belt hook is secure.

IMPORTANT: When attaching or replacing the belt hook, use only the screw 16 that is provided. Be sure to securely tighten screw.

The belt hook 15 can be attached to either side of the tool using only the screw 16 provided, to accommodate left- or right-handed users. If the hook is not desired at all, it can be removed from the tool.

To move belt hook, remove the screw 16 that holds the belt hook in place then reassemble on the opposite side. Be sure to securely tighten screw.

OPERATION

Instructions for Use

 **WARNING:** Always observe the safety instructions and applicable regulations.

 **WARNING:** To reduce the risk of serious personal injury, turn tool off and disconnect battery pack before making any adjustments or removing/installing attachments or accessories. An accidental start-up can cause injury.

Proper Hand Position

 **WARNING:** To reduce the risk of serious personal injury, ALWAYS use proper hand position as shown.

 **WARNING:** To reduce the risk of serious personal injury, ALWAYS hold securely in anticipation of a sudden reaction.

Proper hand position requires one hand on the main handle as shown in Figure D.

Select Operating Mode (Fig. C)

Read the following steps before operating the IR Thermometer.

Choose Units of Measurement

Turn the unit on by engaging the trigger. Once the screen comes on, push the C/F button until the unit of measurement is on the correct setting for the application.

Choose Emissivity

Turn the unit on by engaging the trigger; once the screen comes on push the EMS button for emissivity adjustment. When then EMS is flashing on the screen, use the up or down arrow buttons to choose the emissivity. Please refer to the chart in order to choose the correct emissivity. Remember, emissivity is adjustable by 0.01.

NOMINAL EMISSIVITY TABLE

Material	Value	Material	Value
Default****	0.95	Lead*	0.50
Aluminum*	0.30	Oil	0.94
Asbestos	0.95	Paint	0.93
Asphalt	0.95	Plastic**	0.95
Brass*	0.50	Rubber	0.95
Ceramic	0.95	Sand	0.90
Concrete	0.95	Steel*	0.80
Copper*	0.60	Water	0.93
Glass (plate)	0.85	Wood***	0.94
Iron*	0.70		
* Oxidized			
** Opaque, over 20 mils			
*** Natural			
**** Factory Setting			

Choose Alarm Settings and High/Low Temperatures

- Engage the trigger to turn the unit on.
- Push the ALM button.
- When the ALM is flashing on the screen use the up and down arrows to select the alarm type.
 - Alarm 1 temperature has reached the set limit, indicated by the red/blue LED 13
 - Alarm 2 temperature has reached the set limit, indicated by a beeper sound
 - Alarm 3 temperature has reached the set limit, indicated by both the LED and the beeper
- Push the ALM button again to confirm selection.
- The HAL (high alarm) will now flash. Use the up and down arrows to select the high temperature limit. When the temperature is exceeded, the alarm will activate.
- Push the ALM button. The LAL (low alarm) will now flash. Use the up and down arrows to select the low temperature limit. When the temperature has descended, the alarm will activate.
- Press ALM button again for the main screen.
- Temperature readings can now be taken.

Distance to Spot (Fig. D)

IR Thermometers have a "Cone Effect" where the further the thermometer is from the object, the larger the area being measured. The IR Thermometer has a 12:1 distance to spot (12:1) ratio: for every 300 mm away from the object it will measure 25 mm. The object that is being tested needs to be larger than the spot size to ensure accurate readings.

Key Notes If Having Trouble Taking Measurement

- Make sure to apply masking tape or flat black paint to surfaces that are highly reflective (use the default 0.95 emissivity setting).
- Make sure to have the correct emissivity for the material you are testing. Refer to **Emissivity** and **Nominal Emissivity Table**.
- Clean the material before testing if there is heavy dirt, grease, etc.

Operating Tips

- Use only the 12 V DeWALT lithium-ion battery.
- Ensure batteries are in good working condition. If the low battery indicator light is flashing, the batteries need to be recharged.
- To extend battery life, release the IR Thermometer trigger when not taking temperature readings.

MAINTENANCE

Your DeWALT power tool has been designed to operate over a long period of time with a minimum of maintenance. Continuous satisfactory operation depends upon proper tool care and regular cleaning.



WARNING: To reduce the risk of serious personal injury, turn tool off and disconnect battery pack before making any adjustments or removing/installing attachments or accessories. An accidental start-up can cause injury.

The charger and Infrared Thermometer are not serviceable. There are no serviceable parts inside the charger or Infrared Thermometer.

Troubleshooting

The IR Thermometer Does Not Turn On

- Make sure the 12 V battery is charged.
- While the IR Thermometer may be stored in temperatures up to 85 °C (185 °F), the IR Thermometer has a built-in protection circuit that will not allow it to operate at temperatures in excess of 40 °C (104 °F). If the IR Thermometer has been stored in extremely hot temperatures, allow it to cool. The IR thermometer will not be damaged by pressing the ON/OFF button before cooling to its proper operating temperature.



Lubrication

Your power tool requires no additional lubrication.



Cleaning



WARNING: Blow dirt and dust out of the main housing with dry air as often as dirt is seen collecting in and around the air vents. Wear approved eye protection and approved dust mask when performing this procedure.



WARNING: Never use solvents or other harsh chemicals for cleaning the non-metallic parts of the tool. These chemicals may weaken the materials used in these parts. Use a cloth dampened only with water and mild soap. Never let any liquid get inside the tool; never immerse any part of the tool into a liquid.

Optional Accessories



WARNING: Since accessories, other than those offered by DeWALT, have not been tested with this product, use of such accessories with this tool could be hazardous. To reduce the risk of injury, only DeWALT recommended accessories should be used with this product.

Consult your dealer for further information on the appropriate accessories.

Protecting the Environment



Separate collection. Products and batteries marked with this symbol must not be disposed of with normal household waste.

Products and batteries contain materials that can be recovered or recycled reducing the demand for raw materials. Please recycle electrical products and batteries according to local provisions. Further information is available at www.2helpU.com.

Rechargeable Battery Pack

This long life battery pack must be recharged when it fails to produce sufficient power on jobs which were easily done before. At the end of its technical life, discard it with due care for our environment:

- Run the battery pack down completely, then remove it from the tool.
- Li-Ion cells are recyclable. Take them to your dealer or a local recycling station. The collected battery packs will be recycled or disposed of properly.

Belgique et Luxembourg België en Luxemburg	DeWALT – Belgium BVBA Egide Walschaertsstraat 16 2800 Mechelen	Tel: NL 32 15 47 37 63 Tel: FR 32 15 47 37 64 Fax: 32 15 47 37 99	www.dewalt.be enduser.BE@sbdinc.com
Danmark	DeWALT (Stanley Black&Decker AS) Roskildevej 22 2620 Albertslund	Tel: 70 20 15 10 Fax: 70 22 49 10	www.dewalt.dk kundeservice.dk@sbdinc.com
Deutschland	DeWALT Richard-Klinger-Str. 11 65510 Idstein	Tel: 06126-21-0 Fax: 06126-21-2770	www.dewalt.de infowge@sbdinc.com
Ελλάς	DeWALT (Ελλάς) Α.Ε. ΕΔΠΑ-ΓΡΑΦΕΙΑ : Στραβανος 7 & Λ. Βουλιαγμένης, Πλυγιάδα 166 74, Αθήνα SERVICE : Ημερος Τόπος 2 (Χάνι Αδών) – 193 00 Ασπρόπυργος	Τηλ: 00302108981616 Φαξ: 00302108983570	www.dewalt.gr Greece.Service@sbdinc.com
España	DeWALT Ibérica, S.C.A. Parc de Negocios "Mas Blau" Edificio Muntadas, c/Bergadà, 1, Of. A6 08820 El Prat de Llobregat (Barcelona)	Tel: 934 797 400 Fax: 934 797 419	www.dewalt.es respuesta.postventa@sbdinc.com
France	DeWALT (Stanley Black & Decker France SAS) 62 Chemin de la Bruyère CS 60105, 69574 DARDILLY Cedex	Tel: 04 72 20 39 20 Fax: 04 72 20 39 00	www.dewalt.fr scuff@sbdinc.com
Schweiz Suisse Svizzera	DeWALT In der Luberzen 42 8902 Urdorf	Tel: 044 – 755 60 70 Fax: 044 – 730 70 67	www.dewalt.ch service@rofoag.ch
Ireland	DeWALT Building 4500, Kinsale Road Cork Airport Business Park Cork, Ireland	Tel: 00353-2781800 Fax: 01278 1811	www.dewalt.ie Sales.ireland@sbdinc.com
Italia	DeWALT via Energypark 6 20871 Vimercate (MB), IT	Tel: 800-014353 39 039-9590200 Fax: 39 039-9590311	www.dewalt.it
Nederlands	DeWALT Netherlands BVPostbus 83, 6120 AB BORN	Tel: 31 164 283 063 Fax: 31 164 283 200	www.dewalt.nl
Norge	DeWALT Postboks 4613 0405 Oslo, Norge	Tel: 45 25 13 00 Fax: 45 25 08 00	www.dewalt.no kundeservice.no@sbdinc.com
Österreich	DeWALT Werkzeug Vertriebsges m.b.H Oberlaaerstrasse 248, A-1230 Wien	Tel: 01 - 66116 - 0 Fax: 01 - 66116 - 614	www.dewalt.at service.austria@sbdinc.com
Portugal	DeWALT Ed. D Diris, Quina da Fonte Rua dos Malhoes 2 2A 2º Esq. Oeiras e S. Juliao da Barra, paço de Arcos e Caxias 2770 071 Paço de Arcos	Tel: +351 214667500 Fax: +351214667580	www.dewalt.pt resposta.posvenda@sbdinc.com
Suomi	DeWALT PL47 00521 Helsinki, Suomi	Puh: 010 400 4333 Faksi: 0800 411 340	www.dewalt.fi asiakaspalvelu.fi@sbdinc.com
Sverige	DeWALT BOX 94 43122 Mölndal Sverige	Tel: 031 68 61 60 Fax: 031 68 60 08	www.dewalt.se kundservice.se@sbdinc.com
Türkiye	Sanayi ve Ticareet Bakanligi tebligince kullanim ömrü 7 yıldır. Stanley Black & Decker Turkey Alet Üretim San. Tic. Ltd.Şti. AND Kozayağı – İçerenköy Mah. Umut Sok. AND Ofis Sit. No: 10-12 / 82-83-84 Ataşehir/İstanbul, Türkiye	Tel: +90 216 665 2900 Faks: +90 216 665 2901	www.dewalt.com.tr support@dewalt.com.tr
United Kingdom	DeWALT, 270 Bath Road; Slough, Berks SL1 4DX	Tel: 01753-567055 Fax: 01753-572112	www.dewalt.co.uk emeaservice@sbdinc.com
Australia / New Zealand	DeWALT 810 Whitehorse Road Box Hill VIC 3128 Australia	Tel: Aust 1800 338 002 Tel: NZ 0800 339 258	www.dewalt.com.au www.dewalt.co.nz
Middle East Africa	DeWALT P.O. Box - 17164, Jebel Ali Free Zone (South), Dubai, UAE	Tel: 971 4 812 7400 Fax: 971 4 2822765	www.dewalt.ae support@dewalt.ae